

Instrumentation Amplifiers and Voltage Controlled Current Sources for LHC cryogenic Instrumentation

Agapito J. A.³, Barradas N. P.², Cardeira F. M.², Casas J.¹, Fernandes A. P.², Franco F. J.³, Gomes P.¹, Goncalves I. C.², Cachero A. H.³, Lozano J.³, Martin M. A.³, Marques J. G.², Paz A.³, Prata M. J.², Ramalho A. J. G.², Rodriguez Ruiz M. A.¹ Santos J. P.³ and Vieira A.²,

¹ CERN, LHC Division, Geneva, Switzerland.

² Instituto Tecnológico e Nuclear (ITN), Sacavém, Portugal.

³ Universidad Complutense (UCM), Electronics Dept., Madrid, Spain. agapito@fis.ucm.es

Abstract

Instrumentation amplifiers and voltage controlled current sources have been designed by using single operational amplifiers (OPA124, TLE2071 and OPA627). Their performance has been evaluated in the laboratory and under neutron radiation. On line measurements of the offset voltages, offset currents, closed loop gain, CMRR and bias currents were performed on the amplifiers. The current sources were set to a constant value and the current was monitored on-line. The radiation tolerance of commercial voltage references has also been investigated.

The radiation was performed out in ITN (Portugal) research nuclear reactor. In comparison to previous experimental campaigns the gamma radiation has been reduced by a factor 15 for a given neutron dose. This is achieved thanks to a recently constructed facility for neutron beam extraction.

I. INTRODUCTION

The irradiations were performed using a dedicated irradiation facility recently built at the Portuguese Research Reactor. The components under test were mounted on several PCBs, in a simple support placed inside a cylindrical cavity created in one of the beam tubes of the reactor. For these experiments, the reactor was operated at the nominal power of 1 MW. The fluence of $5 \cdot 10^{13} \text{ n} \cdot \text{cm}^{-2}$ in the central PCB was reached in about 5 days, with 14 hours operation + 10 hours stand-by per day.

The thermal neutron component of the beam was cut by a 0.7 cm thick boral shield and a 4 cm thick Pb shield was used to reduce the total gamma dose below 1 kGy for the central PCB. The neutron fission fluxes were measured with Ni detectors placed at the center of the boxes that contained the PCBs. Figure 1 shows the measured flux distribution as a function of the distance from each box to the support's face closest to the reactor core.

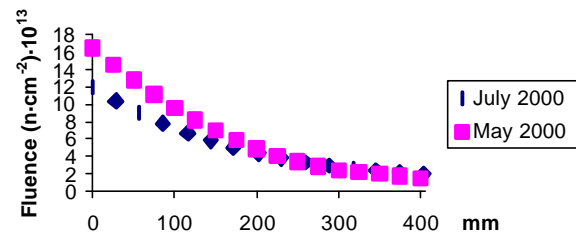

Figure 1: Neutron Flux distribution

A photodiode sensitive to neutrons was placed in several boards, so that the neutron flux was monitored online. A channel for monitoring the gamma radiation was also implemented.

Integration dosimeters placed on the back of first and last PCBs reveal, after completion of the tests, a total gamma dose in the 0.3-1.2 kGy range. With the new set-up the total gamma dose was reduced by a factor of 15 relatively to the irradiations previously reported [1] (for the same neutron fluence), and zero background in standby.

II. INSTRUMENTATION AMPLIFIERS

Two types of instrumentation amplifiers (Figures. 2 & 3) have been designed and exposed to neutron radiation [6]. Two different operational amplifiers have been used to implement the amplifiers in the first run, those tested in earlier irradiation campaigns [1], OPA 124 (DiFET) and TLE2071 (JFET), that survived to the total dose of $3.5 \cdot 10^{13} \text{ n} \cdot \text{cm}^{-2}$, and OPA627 for the second round.

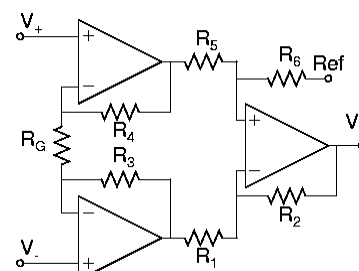

Figure 2: Three OpAmps I. Amplifier

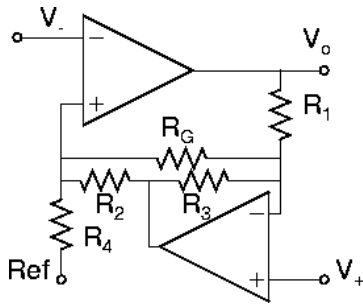

Figure 3: Two OpAmps I. Amplifier

All amplifiers suffered a high increment of the offset voltage after irradiation. This effect is correlated with the behaviour of the single operational amplifiers. The differential gain is similar in all amplifiers. The CMRR is higher in the structure with three single operational amplifiers. This is only due to the better tuning property of this structure. Finally the instrumentation amplifiers with single DIFET operational amplifiers maintain a very low bias and offset currents.

A. Two OPA 124 Instrumentation Amplifiers.

The total dose received was $7 \cdot 10^{13} \text{ n} \cdot \text{cm}^{-2}$, and 1.4 kGy for gamma radiation (figure 4). The differential gain decreases slightly and the CMRR decreases from more than 90 dB to 75 dB. It might be attributed to the decrease of the open loop gains of OpAmp's.

The offset voltage varies between -5 y 15 mV, and remains stable during the break period. The value is similar to that of the single OPA 124, which means that is the contribution of the OpAmp's under neutron and gamma radiation.

The same can be said to the variation of the bias current.

The offset current is insignificant and remains constant during and after the irradiation process.

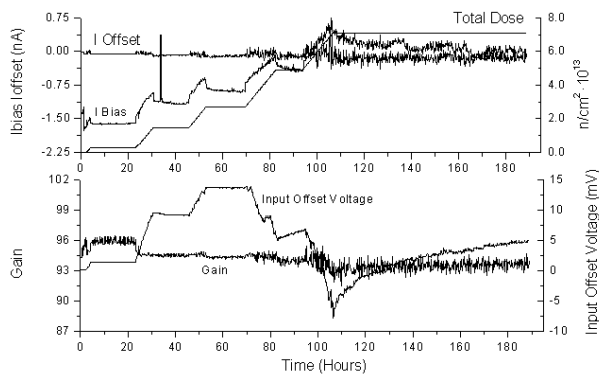

Figure 4: Two OPA124 Instrumentation Amplifier

B. Two TLE 2071 Instrumentation Amplifiers.

The total received dose was the same than the first one (Figure 5).

A small decrease in the differential gain is observed, which could be attributed to a change in the open loop gain of the single OpAmp's.

Small oscillations of the CMRR value take place, but is always higher than 70 dB.

The offset voltage increases with the irradiation flux up to a value as high as 40 mV. Also a slight annealing is observed during the break periods.

The value of the bias current increases up to several tens of nanoAmp, in a similar way as the single OpAmp's under radiation.

The offset current is insignificant (with respect to the bias current), and remains constant during and after the irradiation process.

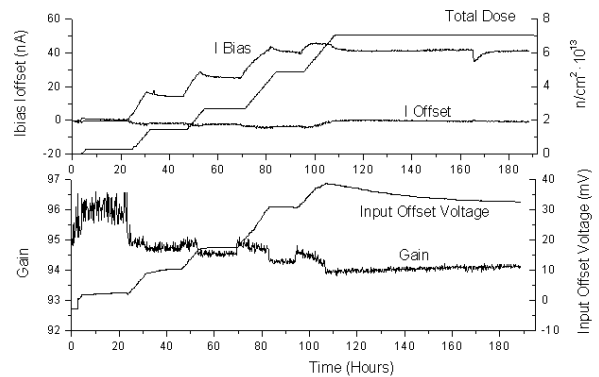

Figure 5: Two TLE2071 Instrumentation Amplifier

C. Three OPA 124 Instrumentation Amplifiers.

The total dose received was $5.9 \cdot 10^{13} \text{ n} \cdot \text{cm}^{-2}$, and 1.4 kGy for gamma radiation (Figure 6). The differential gain is about 95, and the CMRR decreases from 100 dB down to 75 dB. It might be attributed to the decrease of the open loop gains of OpAmp's.

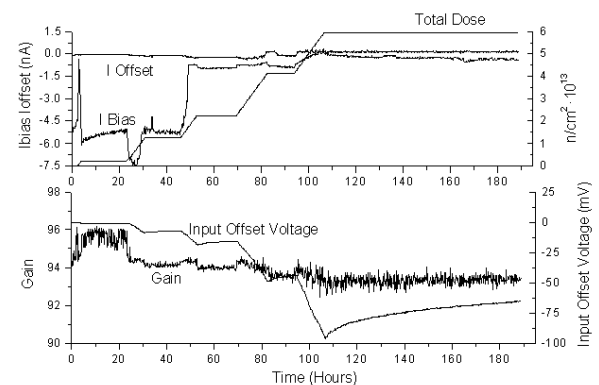

Figure 6: Three OPA124 Instrumentation Amplifier

The offset voltage decreases rapidly, down to -90 mV at the end of the campaign, and a small annealing during the break periods. The value is similar to that of the single OpAmp's under neutron and gamma radiation.

The bias current remains very small, after a short initial increase.

The offset current is insignificant and remains constant during and after the irradiation process.

D. Three TLE 2071 Instrumentation Amplifiers.

The total dose received was the same than the latter (Figure 7).

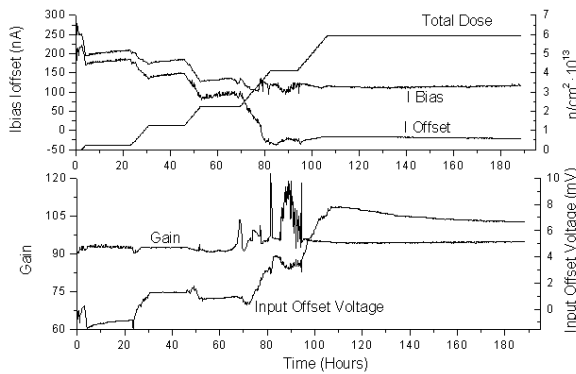

Figure 7: Three TLE2071 Instrumentation Amplifier

The CMRR value remains almost constant at high values.

The offset voltage increases slightly, but no law in the dependence with the irradiation flux can be deduced, as with the single TLE 2071.

The value of the bias current increases with radiation up to 100 nA.

The offset current is insignificant (with respect to the bias current), and remains constant during and after the irradiation process.

E. Three OPA627 Instrumentation Amplifier

The total received dose was $2.3 \cdot 10^{13}$ n/cm² and 400 Gy (Figure 8). This is a broad band DIFET operational amplifier.

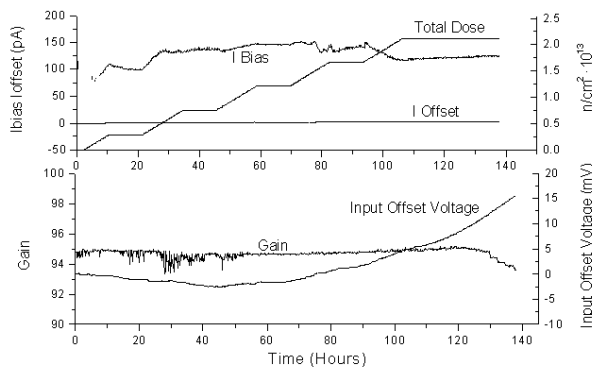

Figure 8: Three OPA627 Instrumentation Amplifier

The gain remains stable during all irradiation campaign, and CMRR is also constant about 100 dB. It has been due to the fact that both neutron total dose and gamma radiation was lower than other amplifiers in previous campaigns, which means that the open loop gain did not change.

There is a drift in the input offset voltage value even after irradiation period. And also the bias current is very low, never higher 150 pA, and the offset current is about to zero.

III. CURRENT SOURCES

Associated with these two instrumentation amplifiers structures, three constant current voltage controlled sources for each amplifier structure have been tested [3] (Figure 9). Positive and negative currents, of the same absolute value, are measured during the irradiation period.

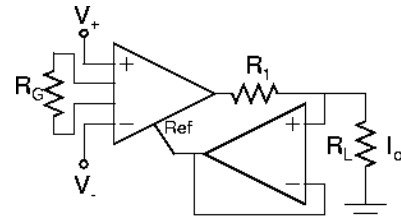

Figure 9: Constant current source

All sources survived the irradiation campaigns, but there is a significant degradation in all of them (Figure 10), specially in the first round. In the second irradiation run, where the gamma background radiation during the standby periods was reduced to zero, all sources were much more stable (Figure 11).

There is an abrupt increase in the output current, that cannot be associated clearly to any cause, at the starting up and stopping down of the reactor in all sources.

A small decrease of the average value of the current as the exposure progresses is been observed. In this case it may be associated to the open loop gain decrease of each single OpAmp's [4].

The absolute values of positive and negative currents are showed in the Figures 10 & 11 for the two rounds.

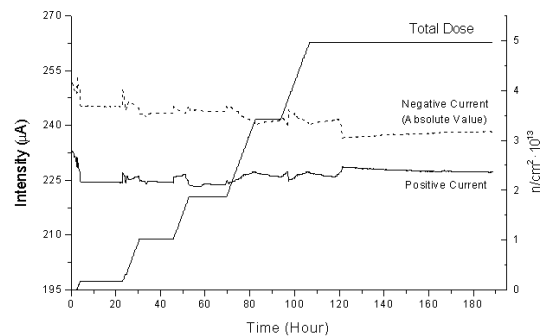

Figure 10: Two Opamp's I. amplifier current source. 1 round

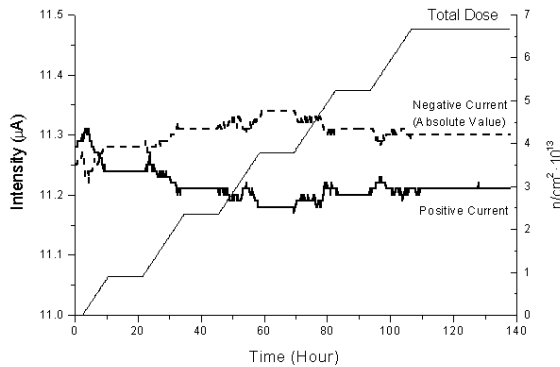

Figure 11: Three Opamp's I. amplifier current source. 2 round

From the data shown in the figures the structure of a constant current source associated to an instrumentation amplifier with 3 DiFET operational amplifiers (Fig 11) is by far the most stable circuit, as far as the constancy of their parameters, for radiation tolerant sources with commercial devices.

Figures 12 and 13 show the evolution of parameters for the Operational Amplifiers used in these structures.

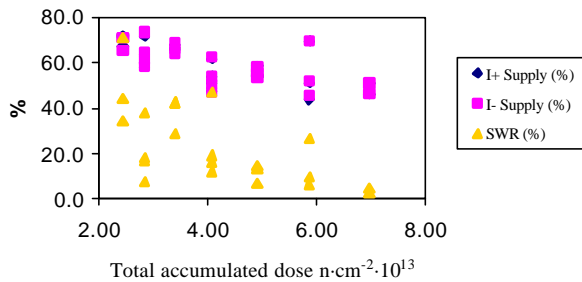

Figure 12: Evolution of parameters for all OPA124

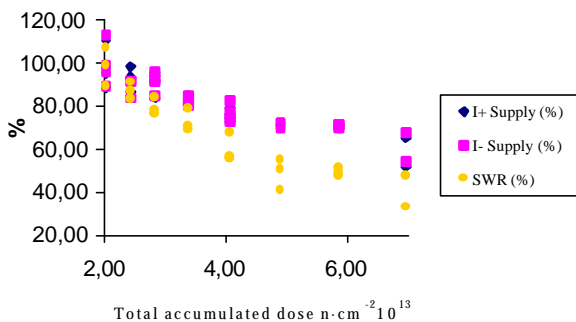

Figure 13: Evolution of parameters for all TLE2071

IV. VOLTAGE REFERENCES

Three *Band Gap* voltage references AD780 were tested (Figure 14). They were polarized with a voltage supply

higher than 13 V. The output voltages and currents were fixed to 3 V and 15 mA (50% of the nominal value), respectively. The output voltages were stable until a total dose of $5 \cdot 10^{12}$ n/cm² is reached. From that value up to $2 \cdot 10^{13}$ n/cm², accumulated dose, the voltage decreases quickly down to zero. After an annealing interval, but in the middle of an irradiation period ($4.8 \cdot 10^{13}$ n/cm²), the voltages rise up slightly and finally all devices are destroyed.

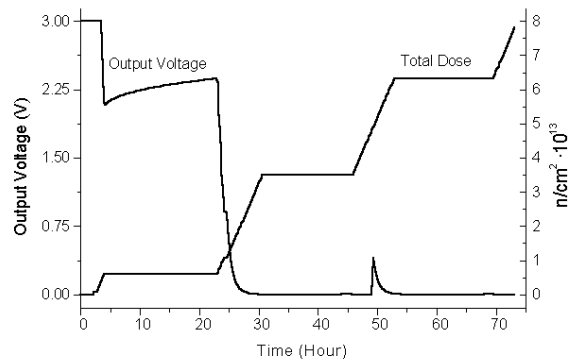

Figure 14: AD780 output Voltage & total dose

The supply currents behave exactly equal to the output voltages.

Three *zener* voltage References REF02 with an output voltage of 5 V and a voltage supply higher than 13.5 V. with an output current of 15 mA (50% of the nominal value) were tested (Figure 15).

The output voltages are stable until a total dose of $1.3 \cdot 10^{13}$ n/cm² is received, and then there is a sudden drop of the output voltages until a value slightly lower than 3.5 V. From that value the output voltages decrease gently and when the total accumulated dose is about $5.5 \cdot 10^{13}$ n/cm², the output voltages reach zero. Only one device recovers the output value of 3 V during the standby period but when the reactor starts up again goes to zero.

The supply currents behave like the output voltages. But the decrease between $1.3 \cdot 10^{13}$ y $5 \cdot 10^{13}$ n/cm² is higher for the currents. All devices were destroyed.

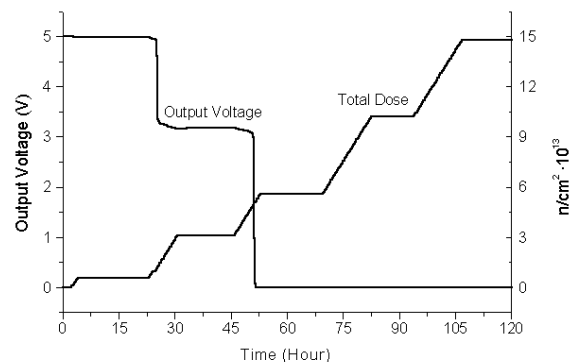

Figure 15: REF02 output Voltage & total dose

V. CONCLUSIONS

The new source built by ITN allows to do fast neutron irradiations with a decrease of the total gamma dose by a factor of 15 related to the previous campaigns. During stand-by time, the background radiation is reduced to zero by moving away the reactor core.

It has been found that the structure of a three Operational amplifiers Instrumentation amplifier is more stable. The DiFET Opamp's give is more stable than any other. However, the change of slew rate of these amplifiers is not as uniform as the JFET's.

Buried zener references are better than band gap ones, although no voltage reference survived after being exposed to a total dose higher than $2 \cdot 10^{13}$ n/cm².

VI. ACKNOWLEDGEMENTS

This work has been financed by the co-operation agreement K476/LHC between CERN & UCM, by the Spanish research agency CICYT (TIC98-0737), by the Private Foundation "Miguel Casado San José", and by the Portuguese research agency ICCTI (CERN/15181/99).

VII. REFERENCES

- [1] "Preliminary test for radiation tolerant electronic components for the LHC cryogenic system" J. A. Agapito, F. M. Cardeira, J. Casas, A. Duarte, A. P. Fernandes, F. J. Franco, M. J. Gil, P. Gomes, I. C. Gonçalves, A. Hernández Cachero, U. Jordung, M. A. Martín, J. G. Marques, A. Paz, A. J. G. Ramalho, M. A. Rodríguez Ruiz and J. P. Santos. Workshop LEB 99, September 20-24th, Snowmass (Colorado, USA).
- [2] "Burr Brown Operational Amplifiers Design and Applications". Jerald G. Graeme, Gene E. Tobey, Lawrence P. Huelsman. 1971.
- [3] "Make a precision current source or current sink". R. Mark Stitt .Burr-Brown Application Bulletin
- [4] "The Effects of Radiation on Electronic Systems" Second Edition, G.e C. Messenger and M. S. Ash.
- [5] "The Art of Electronics" 2nd. Edition. Paul Horowitz, Winfield Hill
- [6] "Analog Electronics with Opamps" 1st Edition. A.J. Peyton, V. Walsh